



# RECYCLING WITH RECYCLE BC





**RECYCLE BC IS RESPONSIBLE FOR RECYCLING  
PACKAGING AND PAPER FOUND IN YOUR HOME.**





**SORTING YOUR RECYCLING AT HOME IS AN IMPORTANT STEP THAT ENSURES AS MUCH MATERIAL IS RECYCLED AS POSSIBLE.**

**BEFORE YOU RECYCLE, MAKE SURE YOUR CONTAINERS ARE EMPTY AND RINSED, AND THAT YOUR PAPER IS CLEAN AND DRY.**





**RECYCLE BC ACCEPTS PLASTIC PACKAGING,  
CARTONS, PAPER CUPS AND METAL PACKAGING  
IN CURBSIDE RECYCLING AND AT DEPOTS.**

**ACCEPTED PAPER IN CURBSIDE AND DEPOT  
RECYCLING INCLUDES PRINTED PAPER,  
PAPER PRODUCTS, CARDBOARD AND PAPER  
PACKAGING FOR DRY GOODS.**

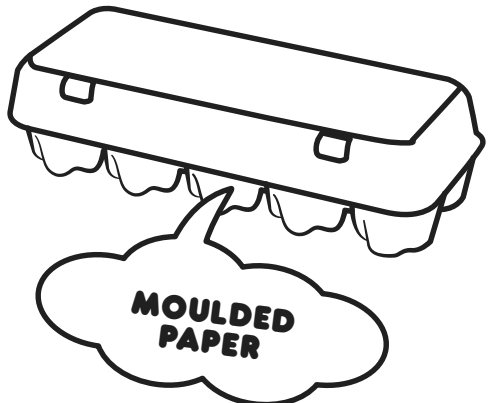
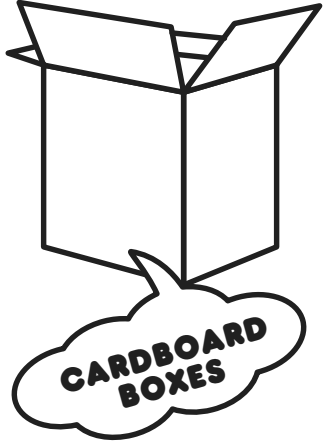
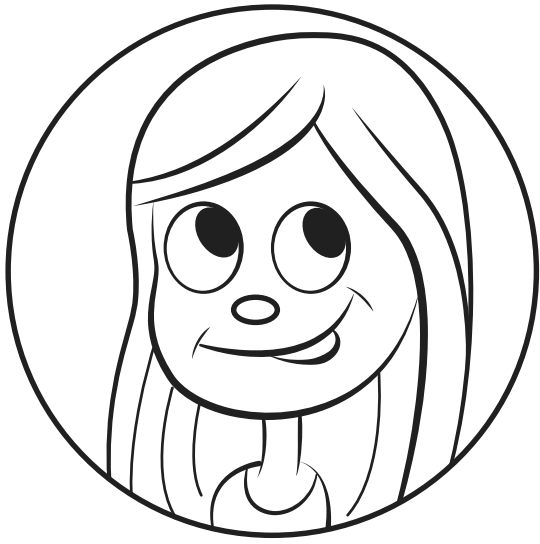
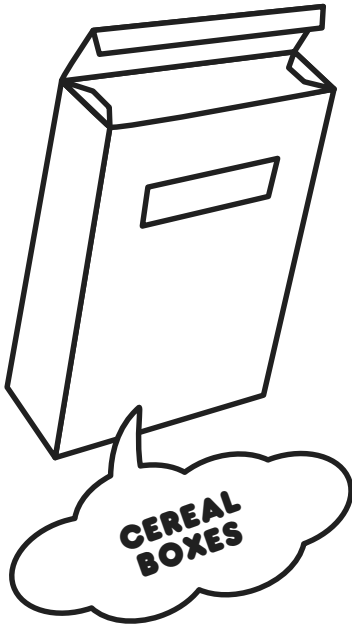
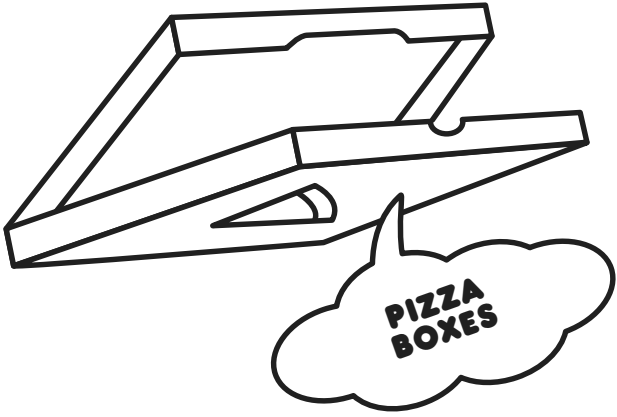



**GLASS CONTAINERS ARE ACCEPTED AT  
DEPOTS AND IN SOME COMMUNITIES IN  
A SEPARATE GLASS BIN.**



**PLASTIC BAGS, FOAM PACKAGING AND  
SOME OTHER FLEXIBLE PLASTIC PACKAGING  
ARE ONLY ACCEPTED AT DEPOTS.**

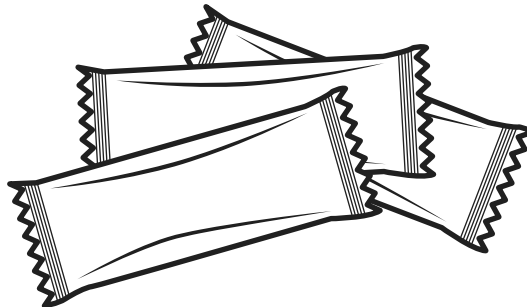
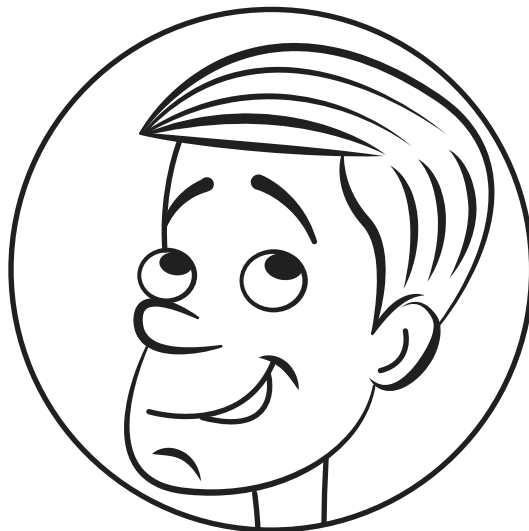
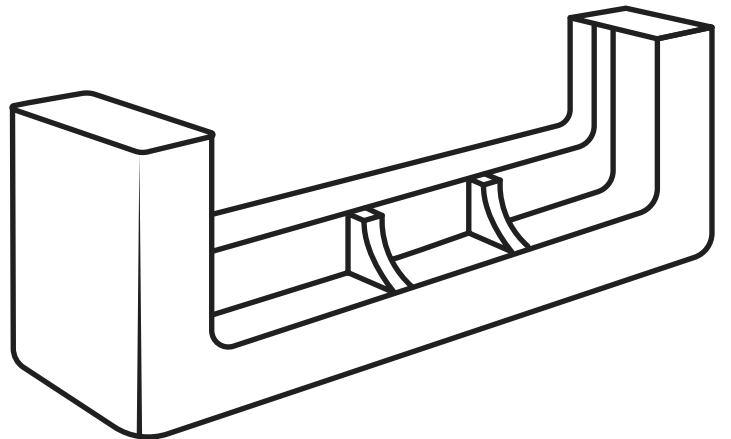
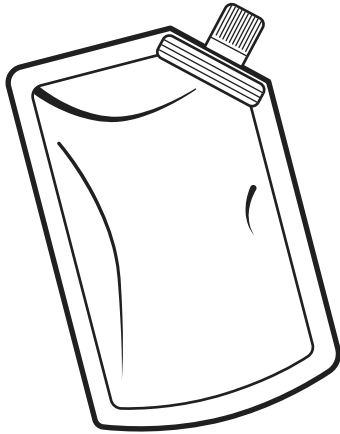

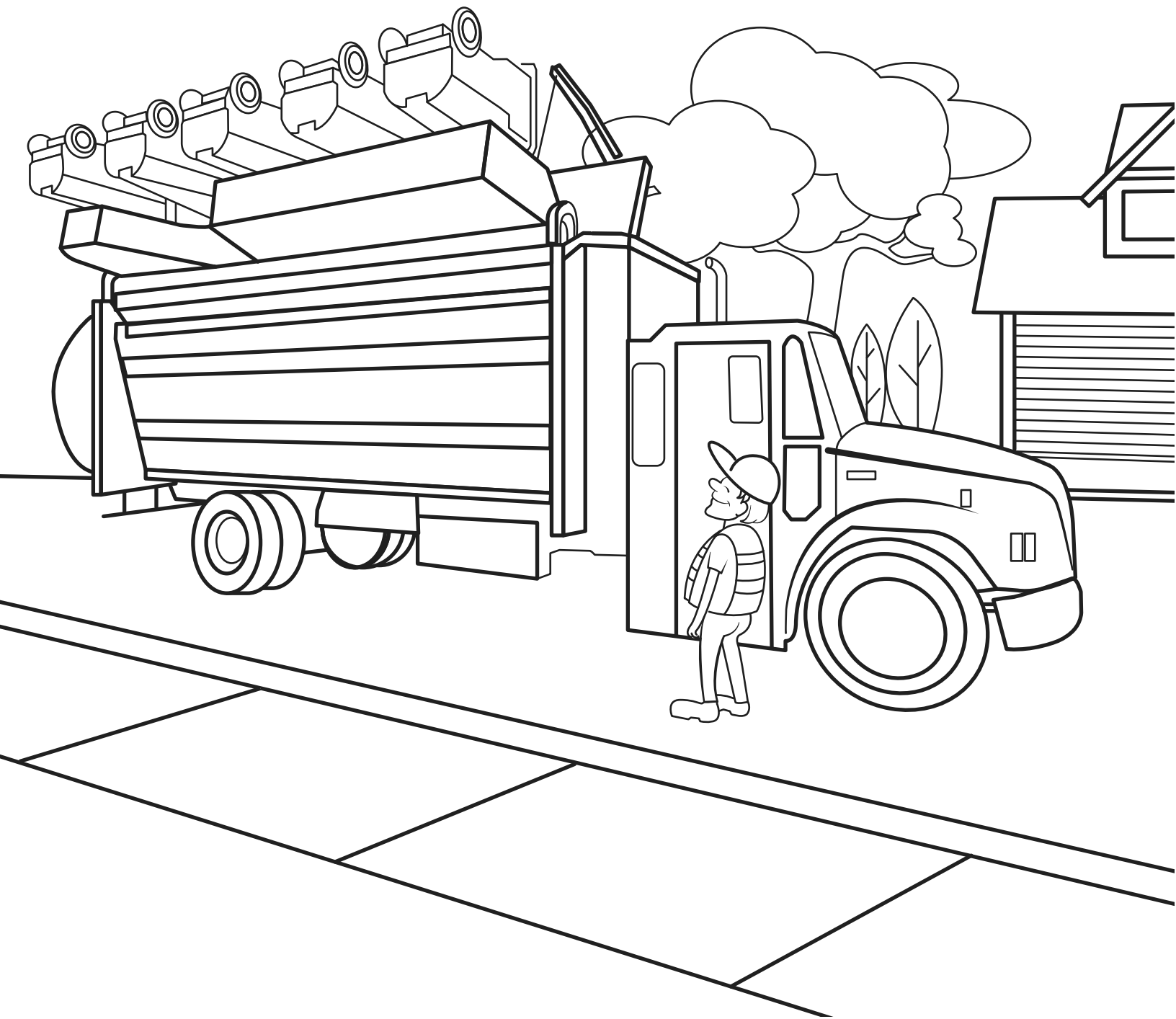

**RECYCLING TRUCK DRIVERS QUICKLY CHECK TO MAKE SURE YOUR RECYCLING IS CLEAN AND CORRECTLY SORTED TO AVOID CONTAMINATION BEFORE PICKING IT UP.**

**SOME ITEMS, LIKE PLASTIC BAGS, FOAM PACKAGING, AND OTHER FLEXIBLE PLASTIC PACKAGING, CAN'T BE COLLECTED FROM HOMES. RETURN THESE ITEMS TO A RECYCLE BC DEPOT. FOLLOW THE DEPOT SIGNS TO SORT ALL YOUR MATERIAL CORRECTLY.**



**AFTER COLLECTION, RECYCLING IS TRANSPORTED TO RECEIVING FACILITIES. PLASTIC IS SORTED BY RESIN TYPE. METAL CONTAINERS, GLASS, FOAM AND PAPER ARE SORTED DURING COLLECTION.**

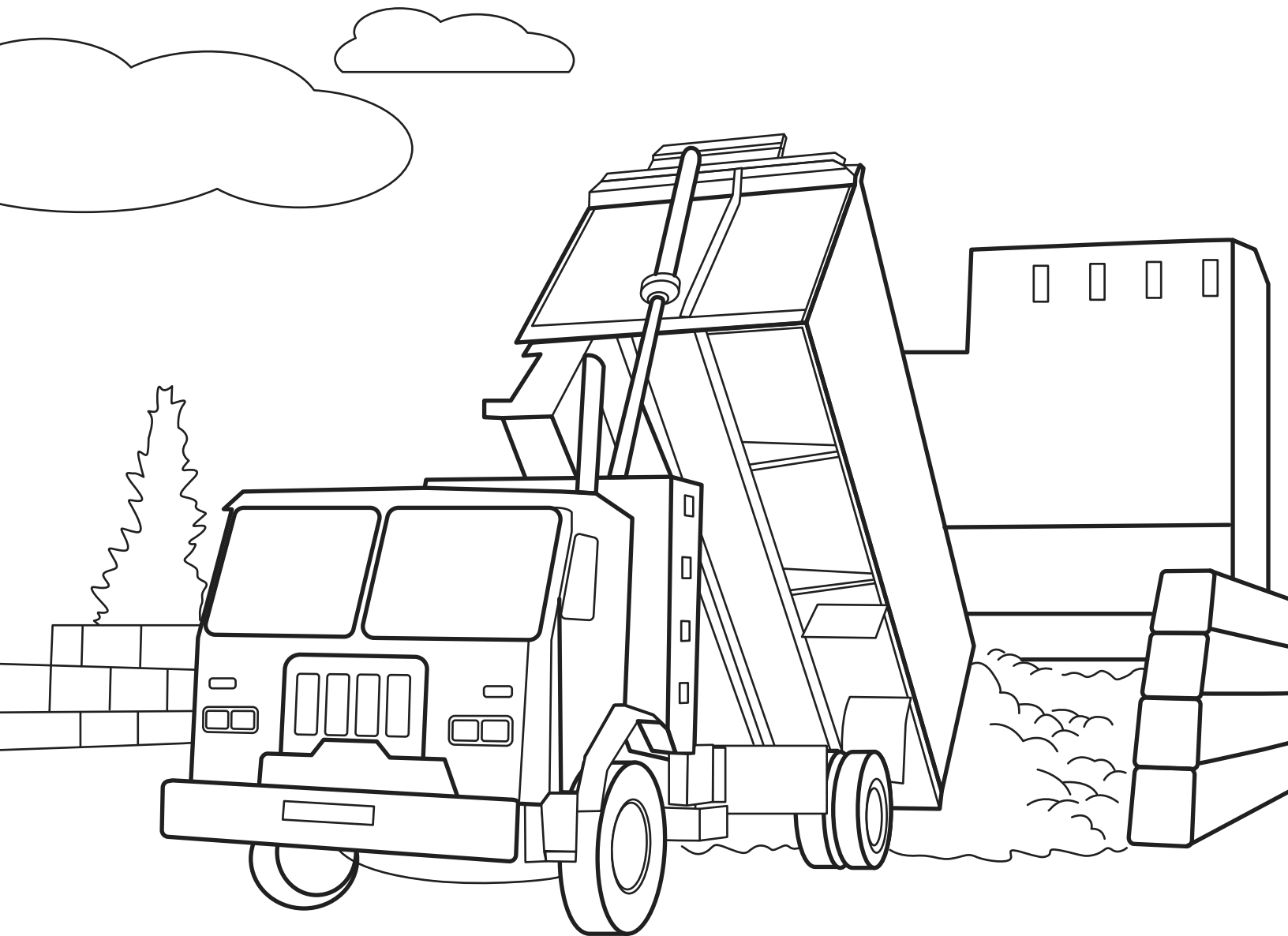

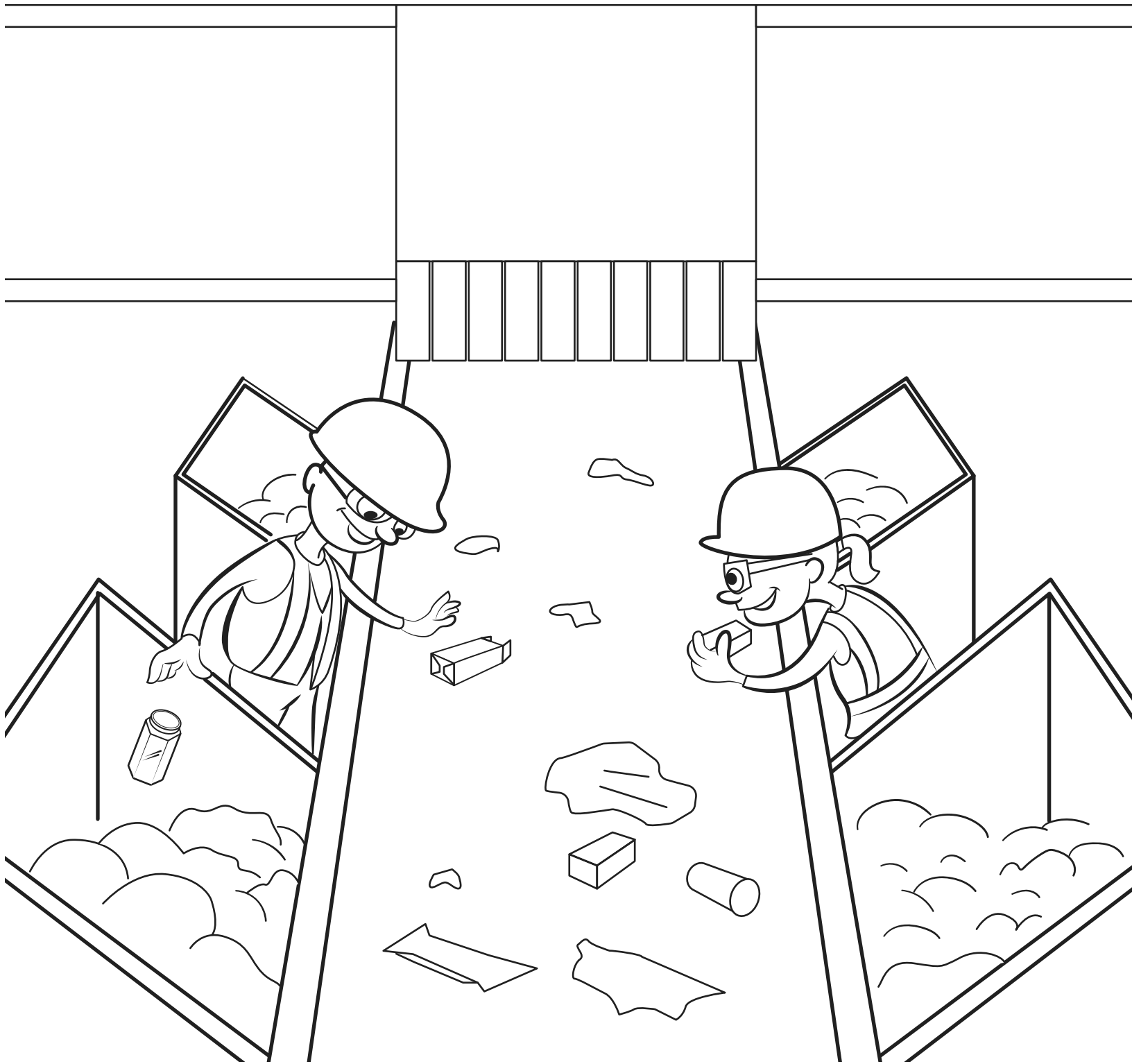

**SOMETIMES MATERIAL IS HAND-SORTED BY PEOPLE AT THE FACILITY, BUT MOSTLY IT'S DONE BY A MACHINE. IN BC, FOR EXAMPLE, ALL PLASTIC GOES THROUGH AN OPTICAL SORTER WHICH CAN TELL WHAT TYPE OF PLASTIC IT IS JUST BY SCANNING IT!**

**AFTER THE FINAL SORTING PROCESS, MATERIAL IS PUT INTO BALES THAT ARE READY TO BE RECYCLED. ON AVERAGE, BALED MATERIAL IS AROUND 1.5 METERS TALL AND CAN WEIGH AS MUCH AS 750 KILOGRAMS.**



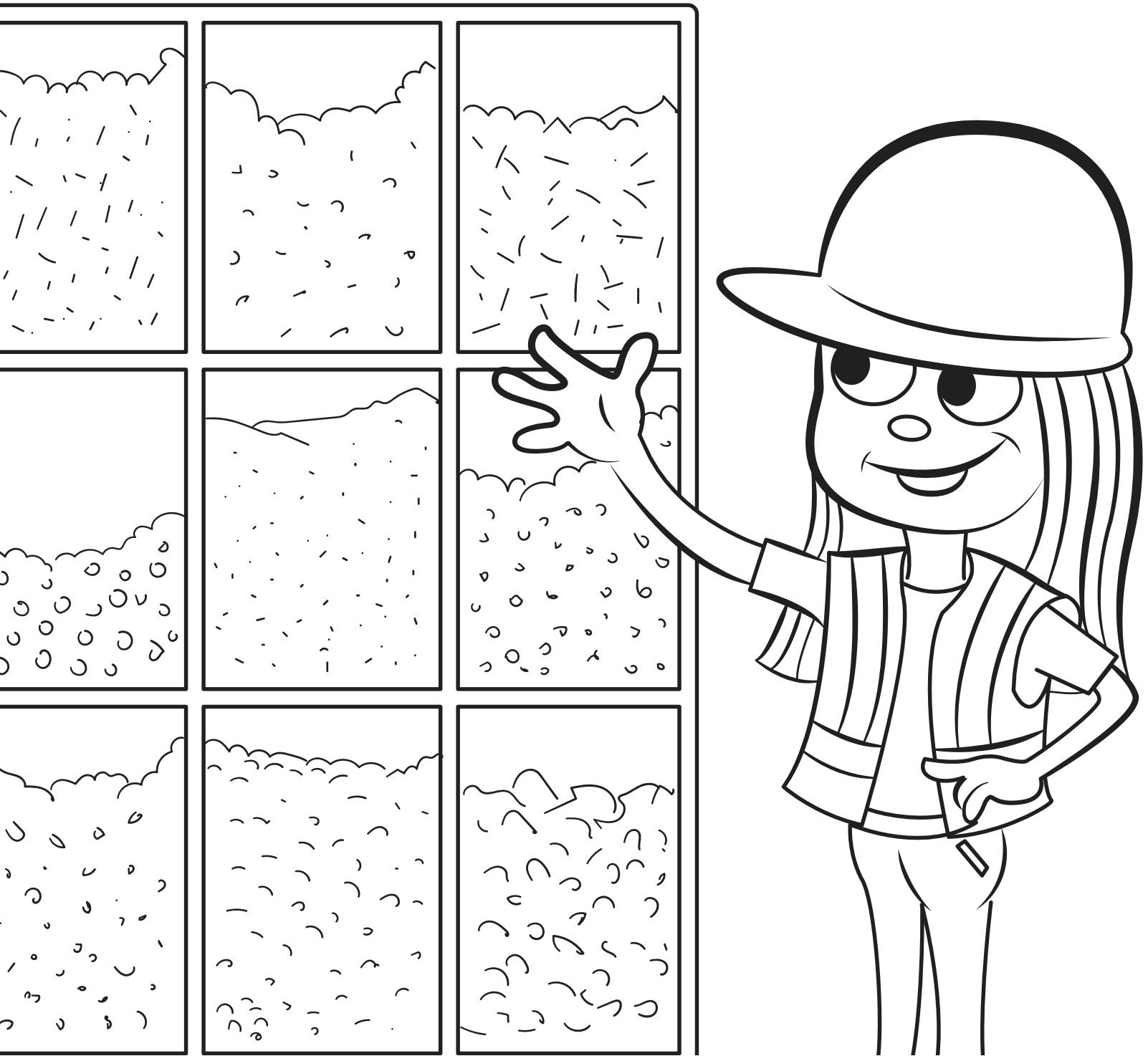

**MANY MATERIALS ARE SHREDDED AND PELLETIZED DURING THE RECYCLING PROCESS. OTHERS MIGHT BE BROKEN DOWN INTO THEIR FIBRES OR CRUSHED INTO TINY PIECES. WE CALL THIS “RAW MATERIAL” BECAUSE IT’S USED TO MAKE NEW PACKAGING AND PRODUCTS.**

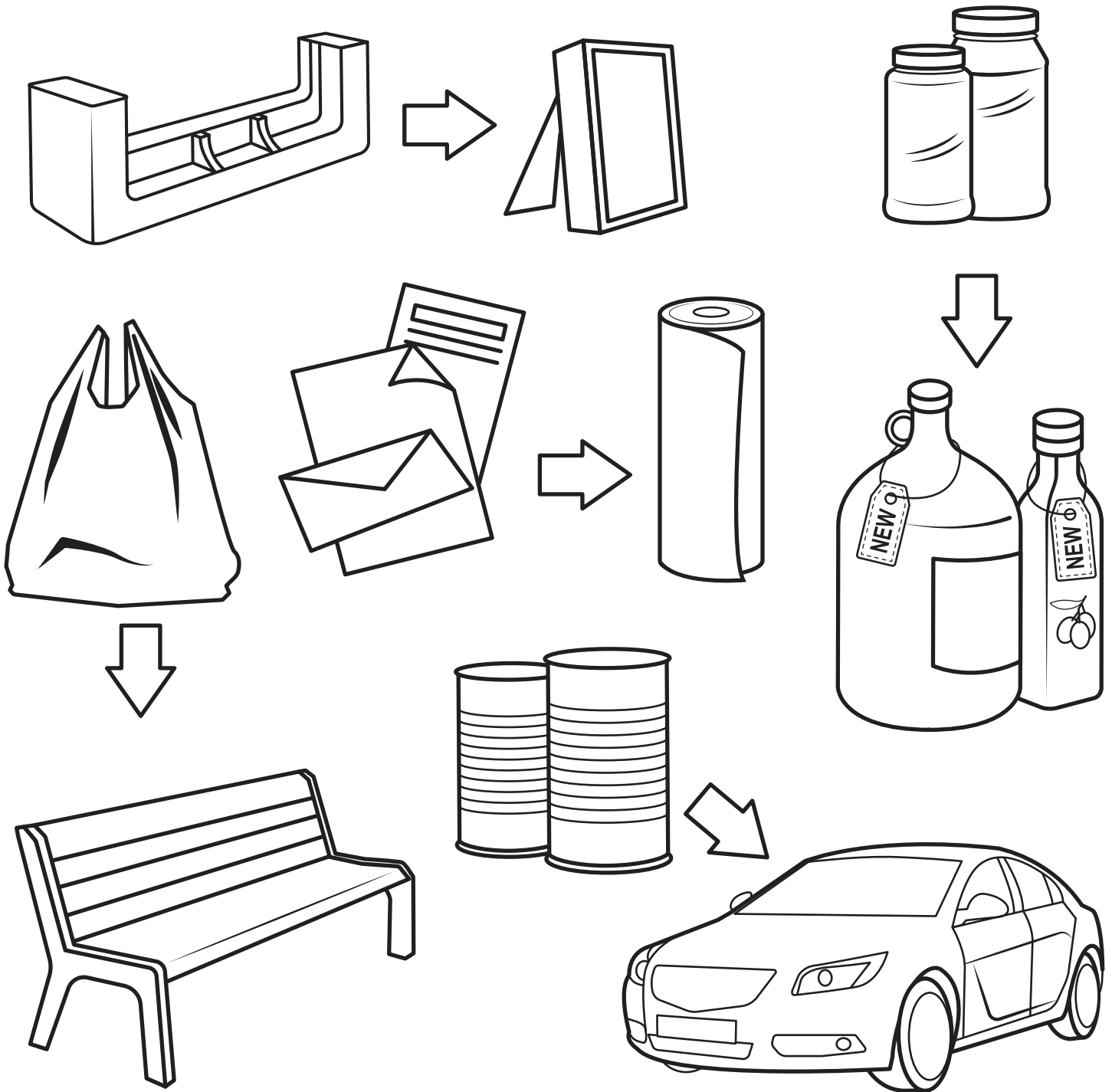

**PACKAGING AND PAPER IS OFTEN RECYCLED INTO NEW PACKAGING. BUT SOME CAN BECOME NEW PRODUCTS LIKE FURNITURE, CARS, PICTURE FRAMES OR PAPER TOWEL.**



**RECYCLING CLOSES THE LOOP ON  
A PRODUCT'S LIFE AND PREVENTS  
THE NEED FOR NEW MATERIAL WHEN  
MAKING PACKAGING OR PRODUCTS.**

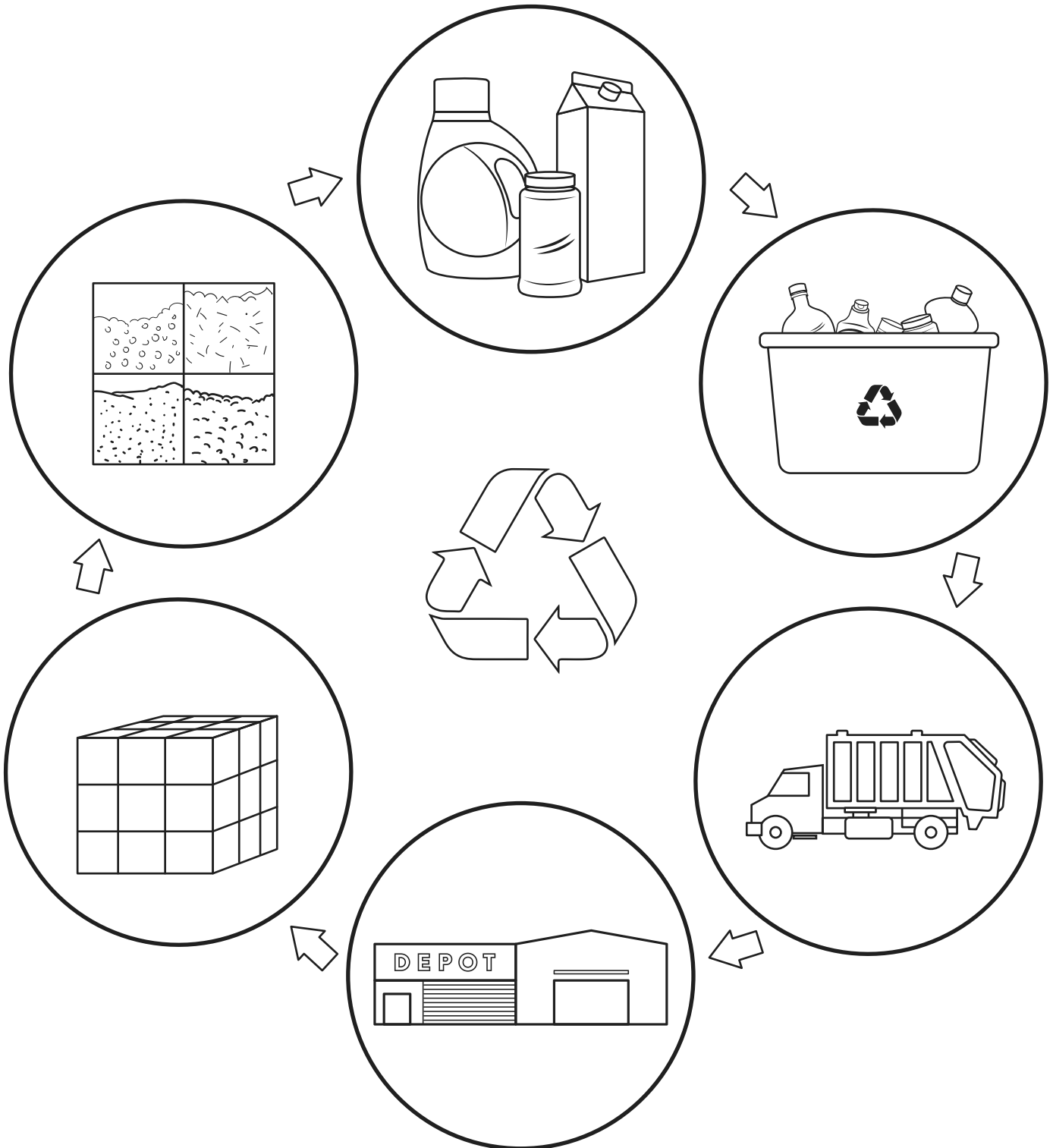



**KEEP BC CLEAN AND GREEN. KEEP  
RECYCLING. TOGETHER, WE CAN  
MAKE A DIFFERENCE.**





**RECYCLEBC™**

**RECYCLEBC.CA**